

GB

Nr. B 092

GB

LED-Alternating Flasher

2 differently coloured light emitting diodes will flash alternately. Adjustable flashing velocity. Operating voltage: 6...12 Volt (9V battery). Usage: flashing adornments, name-plates, for miniature constructions etc.

Tin-plated board! deutsch / español / français / english / niederlands / portugês / suomalainen / grecian



Fitting case:
Kemo G01B

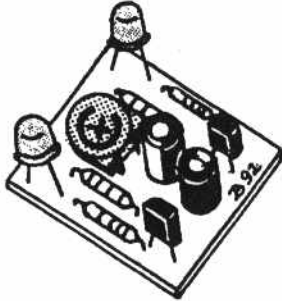

B092



4024028010922

16 **Kemo Germany # 10-192**

D

Nr. B 092 040 519-0

D

LED-Wechselblinker

2 verschiedenfarbige Leuchtdioden blinken abwechselnd auf. Justierbare Blinkgeschwindigkeit. Betriebsspannung: 6...12 Volt (9V Batterie). Anwendung: blinkende Schmuckstücke, Namensschilder, für Modellbau usw.

Platine verzinnt! deutsch / español / français / english / niederlands / portugês / suomalainen / grecian



Passendes Gehäuse:
Kemo G01B

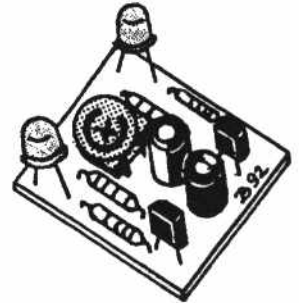

B092



4024028010922

Kemo Germany # 10-192

1

NL / Let vooral op de juiste inbouw van de LED's. De "K"-aansluiting is iets afgevlakt (zie tekening). Met de instelpotentiometer kan de knippersnelheid ingesteld worden.

P / Tenha o cuidado de montar os leds correctamente. O terminal "K" tem um lado ligeiramente achatado (ver a figura). Com a ajuda do potenciometros ajustável é possível ajustar a velocidade do efeito.

SF

Nr. B 092

SF

LED-vuorovilkku

2 eriväristä LED:iä vilkkuvat vuorotellen. Vilkkumistaajuus on säädettävissä. 6...12V (9V paristo). Käyttö: vilkkuvat koristeet, nimikilvet, mallirakentajille jne.

Piirilevy tinattu! deutsch / español / français / english / niederlands / portugês / suomalainen / grecian



Sopiva kotelo:
Kemo G01B

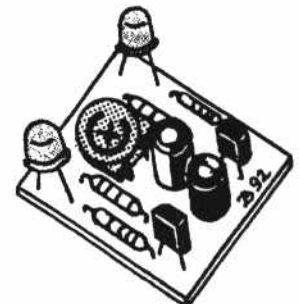
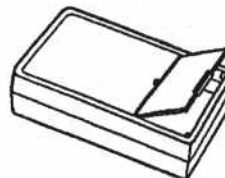

B092



4024028010922

Kemo Germany # 10-192

3

NL

Nr. B 092

NL

LED-wisselknipperlicht

2 LED's met verschillende kleuren gaan afwisselend branden. De knippersnelheid is regelbaar. Bedrijfs-spanning: 6...12V (9V batterij). Toepassing: voor knipperende sieraden disco-petten, voor naambordjes, voor modelbouw enz.

Printplaat vertind! deutsch / español / français / english / nederlands / portugês / suomalainen / grecian



Passend huis:
Kemo G01B

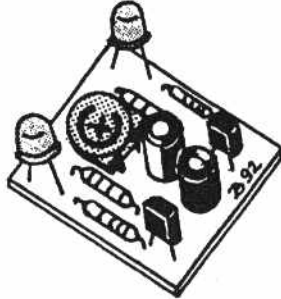

B092



4024028010922

2 **Kemo Germany # 10-192**

15

F

Nr. B 092

F

Clignoteur alternatif à leds

2 diodes lumineuses de couleur différente s'allument alternativement. La fréquence de clignotement est réglable. Alimentation: 6...12V (batterie de 9V). Utilisations: bijoux clignotants, plaque d'entrée avec nom, pour le modélisme, etc.

Plaquette étamée! deutsch / español / français / english / nederlands / portugês / suomalainen / grecian



Boîtier recommandé:
Kemo G01B

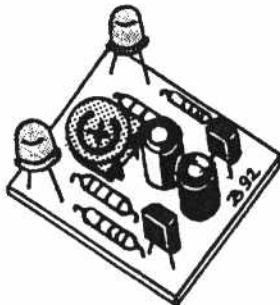

B092



4024028010922

4 **Kemo Germany # 10-192**

13

SF / Ota huomioon LED:in oikea asennus. "K"-napa on vähän litistetty (katso kuva). Trimmeripotentiometrillä voi säätää vilkkumistaajuuden.

F / Veiller au montage correct des leds. Le branchement "K" (cathode) est légèrement aplati (voir schéma). Le potentiomètre permet de régler la fréquence d'allumage.

GB / Please take special care mounting the LED's correctly. The "K"-connection has been slightly flattened (see figure). With the aid of the trimmer potentiometer it is possible to adjust the flashing velocity.

LED's a piscar alternadamente

Circuito para colocar 2 leds a piscar alternadamente. Velocidade ajustável. Tensão de alimentação: 6 a 12V (pode ser usada uma bateria de 9V). Utilização: efeitos luminosos, placas com nome, construções miniatura...

Placa estanhada deutsch / español / français / english / nederlands / português / suomalainen / grecian



Fitting case: Kemo G01B

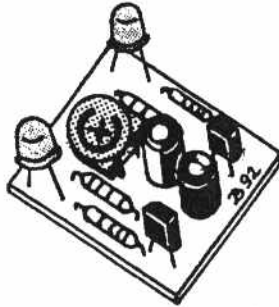

6 Kemo Germany # 10-192

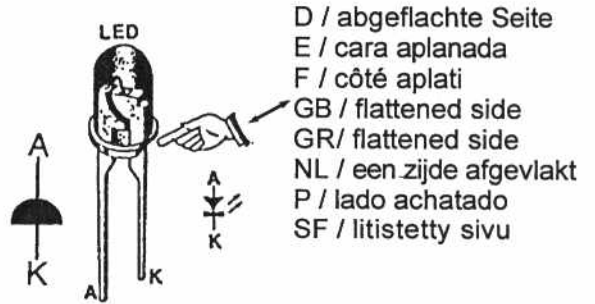
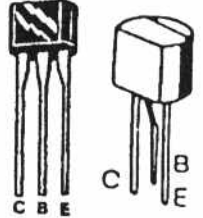
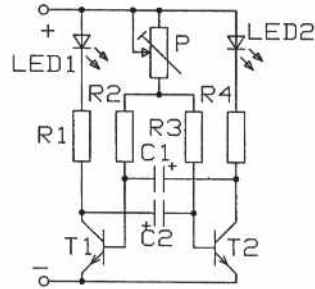

- 6...12V
- D / Akku oder Batterie
- E / Acu o batería
- F / Accu ou batterie
- GB / Accu or battery
- GR Accu or battery
- NL / Accu of batterij
- P / Acu ou bateria
- SF / Akku tai paristo

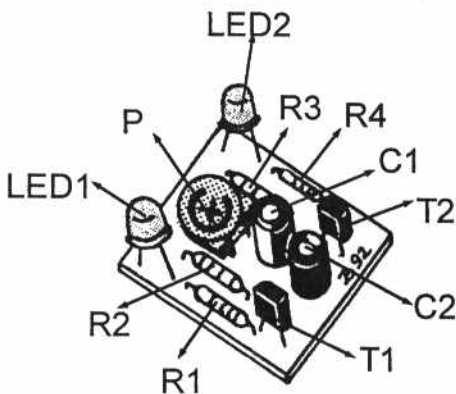
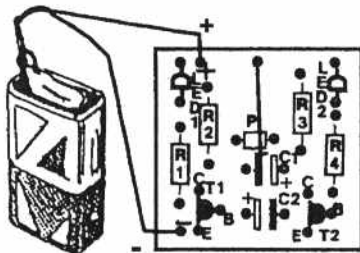

D/ Bitte achten Sie auf den richtigen Einbau der LED's. Der "K" - Anschluß ist leicht abgeflacht (siehe Zeichnung). Mit dem Trimpotentiometer kann die Blinkgeschwindigkeit eingestellt werden.

E/ Por favor, observe Vd. la instalación correcta de los LED's. La conexión "K" es un poco aplanada (mire el dibujo). La velocidad de intermitencias se puede regular con el potenciómetro de ajuste.

E

Nr. B 092

E

LED - luz intermitente alterna

2 diodos luminosos de varios colores relucen por turno. Velocidad de intermitencias ajustable. Tensión de servicio: 6...12 Volt (9V batería). Aplicación: adornos relucidos, placas de nombre, para la construcción de modelo etc.

¡Placa estañada! deutsch / español / français / english / nederlands / portugês / suomalaisen / grecian



**Caja pertinente:
Kemo G01B**

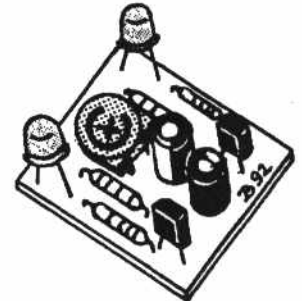

4024028010922

Kemo Germany # 10-192

5

12

GR

Nr. B 092

GR

ΕΝΑΛΛΑΣΜΟΜΕΝΟ ΦΛΑΣ

Δυο LED διαφορετικων χρωματων αναβοσβυνουν εναλλαξ με ρυθμιζομενη ταχυτητα. Καταλληλο για διακοσμησεις, φωτιστικα εφε, πινακιδες κ.τ.λ. Ταση λειτουργιας 6...12 V. Καταναλωση 20 mA.

Tin-plated board! deutsch / español / français / english / nederlands / portugês / suomalaisen / grecian



**Fitting case:
Kemo G01B**

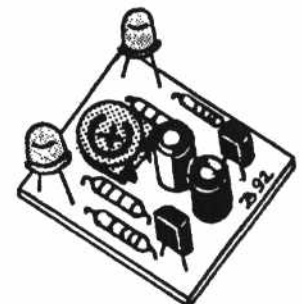

4024028010922

Kemo Germany # 10-192

7

10